

SUNSTREAM

SLX8012B4

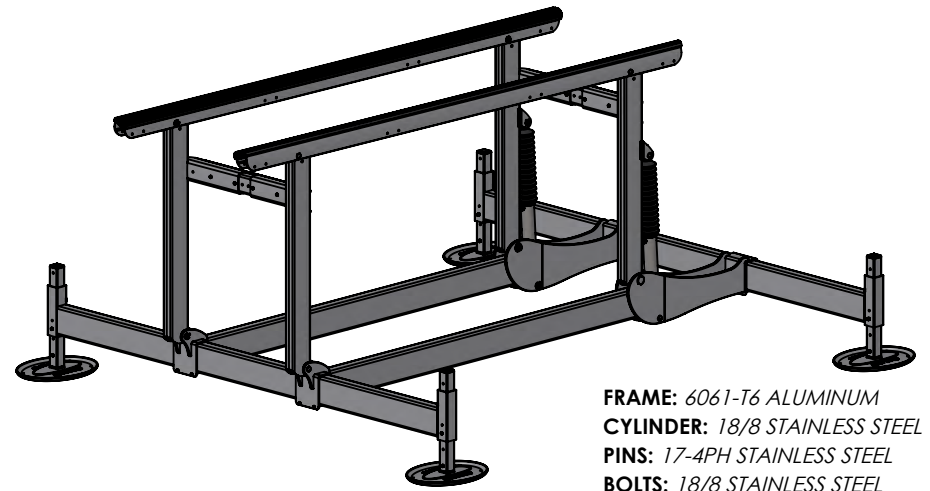

FRAME: 6061-T6 ALUMINUM
CYLINDER: 18/8 STAINLESS STEEL
PINS: 17-4PH STAINLESS STEEL
BOLTS: 18/8 STAINLESS STEEL
NUTS: SILICONE BRONZE
SHIPPING WEIGHT: 814lbs

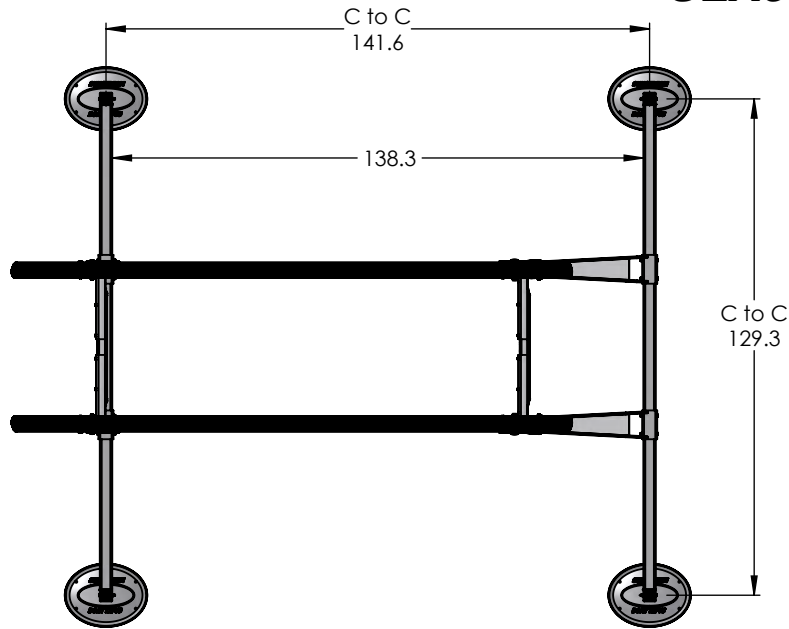
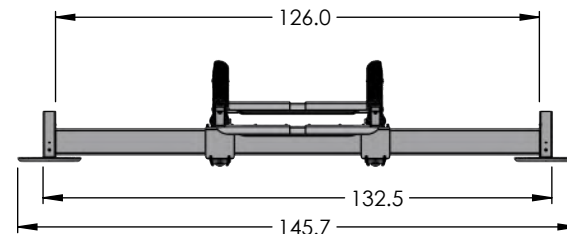
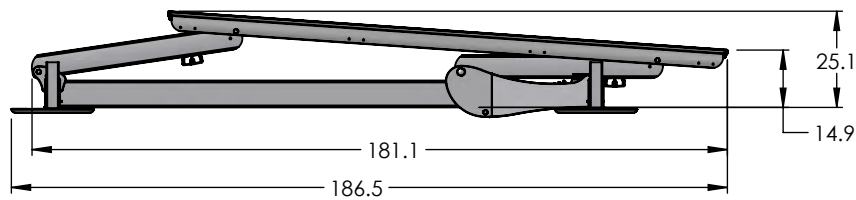
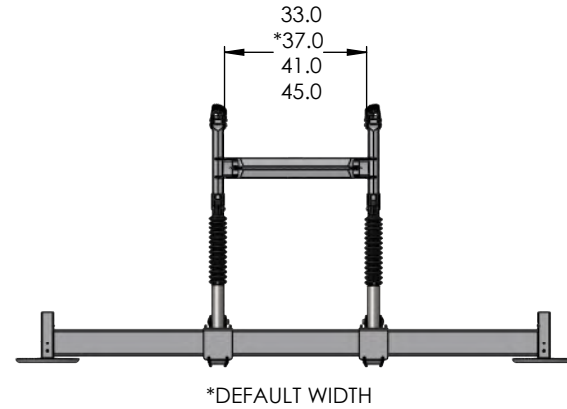
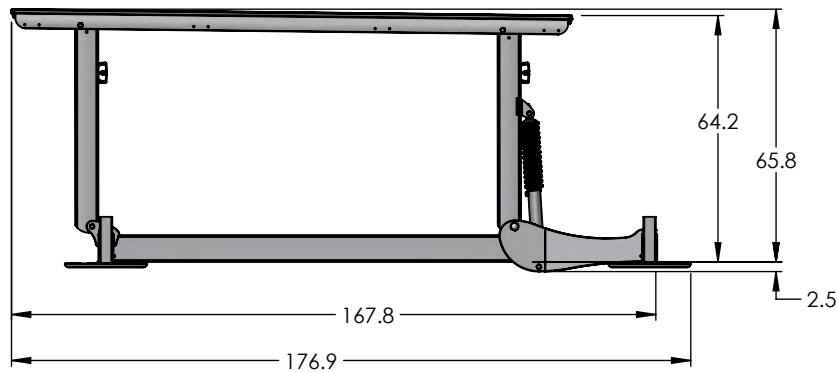

DIMENSIONS IN INCHES